

# XR 1200 Café Racer Triple Clamps 202402

Torque ratio 42,17 N.m  
201024

202402 LB



202402 LA

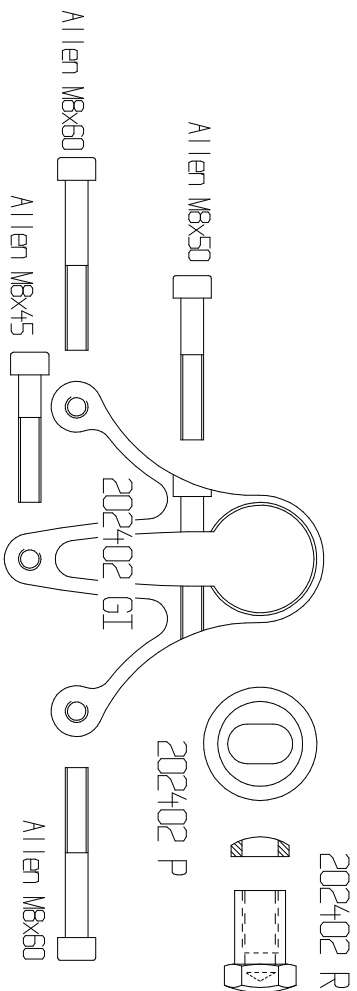

Allen M8x50

Allen M8x60

Allen M8x45

202402 GI

202402 P

Allen M8x60

202402 R

Torque ratio 25,5 N.m  
Allen M8x40



202402 STC

Allen M8x40

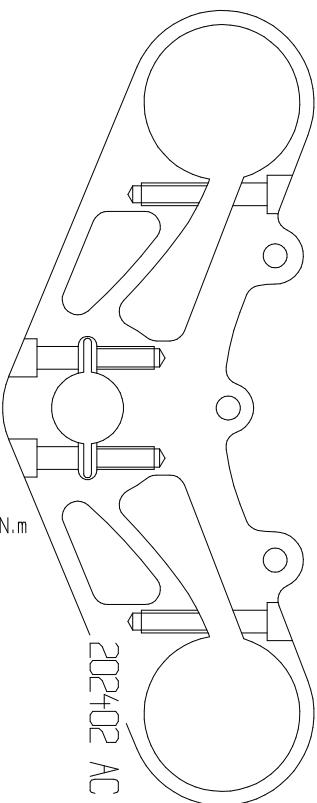

202402 AC

Allen M8x45  
Torque ratio 14,71 N.m

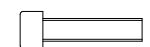
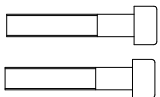

Allen M8x35  
Torque ratio 25,5 N.m



Torque ratio 25,5 N.m  
Allen M8x16

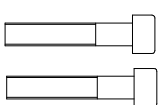

Torque ratio 25,5 N.m  
Allen M8x35

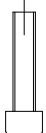
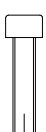

Allen M8x35

202402 DF

